











La Jolla Queen Assembly Instructions

Hardware List includes factory installed bolts and washers for side rails attachment.

A	D	E	F	G	H	I	J	K	L
									
φ1/4"*1.25"	φ1/4"	φ5/16"		φ5/32"*2.5"	φ5/32"*2.5"	φ3/16"*4"		φ5/16"*3.25"	φ5/16"*2"
12PCS	12PCS	8PCS	4PCS	4PCS	1PC	1PC	4PCS	4PCS	8PCS

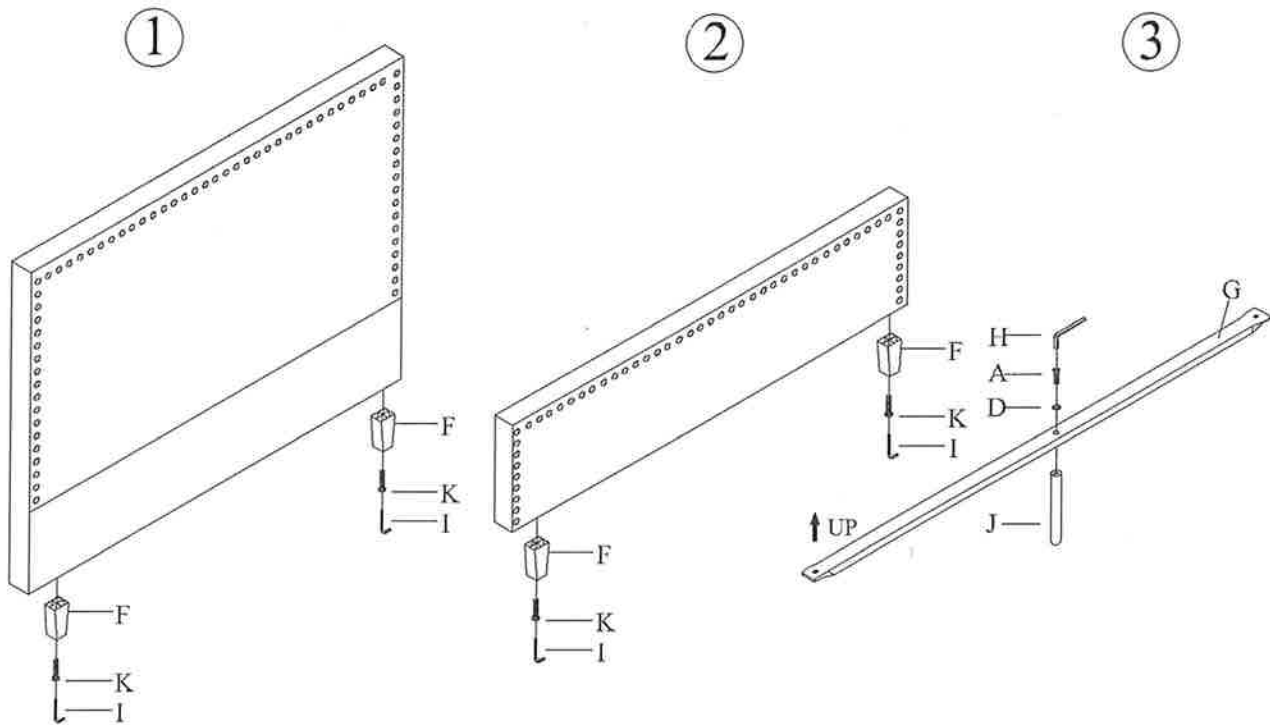

Step#1

Retrieve feet and hardware from HB zipper. Attach bed feet F to the headboard using Wrench I, Bolt K.

Step#2

Attach bed feet F to the footboard using Wrench I, Bolt K.

Step#3

Attach steel center support legs J to the center support rail G using Wrench H, Bolt A and Washer D.











Center support legs J are cable tied in red bags to the center support rails during shipment.

CONGRATULATIONS ON YOUR NEW BED PURCHASE

~Warning: do not move bed after final assembly as it may result in damages to floor and/or bed.~

La Jolla Queen Assembly Instructions

Hardware List includes factory installed bolts and washers for side rails attachment.

A	D	E	F	G	H	I	J	K	L
									
φ1/4"*1.25"	φ1/4"	φ5/16"		φ5/32"*2.5"	φ5/32"*2.5"	φ3/16"*4"		φ5/16"*3.25"	φ5/16"*2"
12PCS	12PCS	8PCS	4PCS	4PCS	1PC	1PC	4PCS	4PCS	8PCS

④

**Bolt L and Washer E are
Factory Installed**

⑤

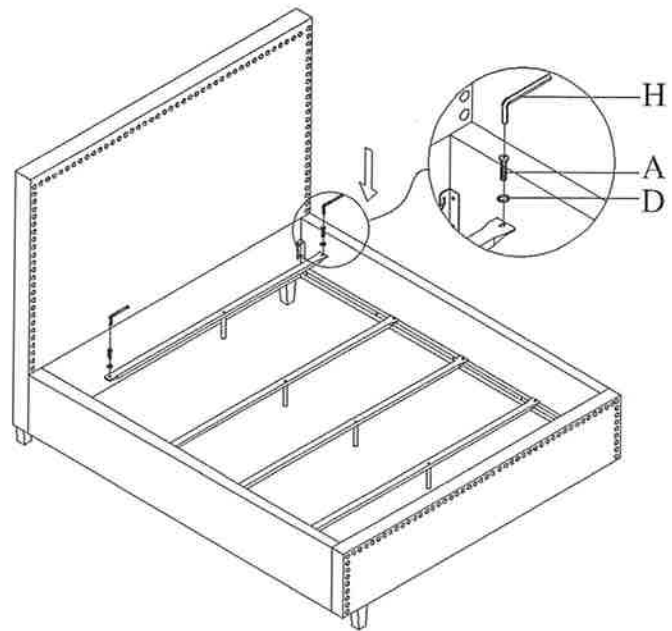
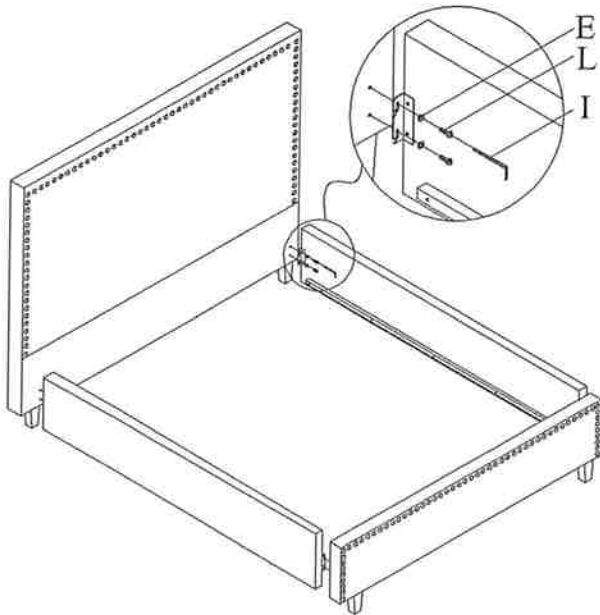

Step#4

Attach side rails to headboard and footboard using Bolt L, Washer E and Wrench I.

Step#5

Move/place bed into final position in bedroom.

Attach steel slat support system to full length steel side support cleats (flat side facing up).

Verify center support legs are perpendicular to the floor for full support.

CONGRATULATIONS ON YOUR NEW BED PURCHASE

~Warning: do not move bed after final assembly as it may result in damages to floor and/or bed.~